

Agilent 8752C

RF Vector Network Analyzer

Product Overview

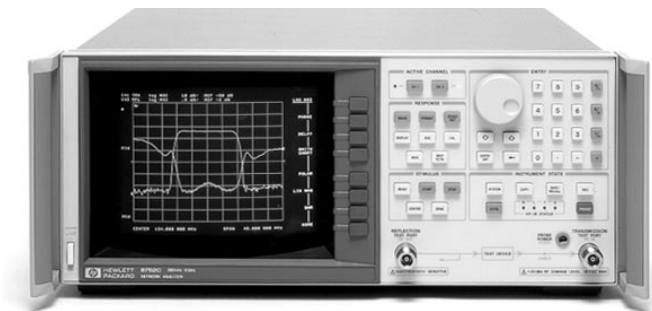

300 kHz to 1.3, 3, or 6 GHz

- **Performance**
- **Value**
- **Ease of use**

The Agilent Technologies 8752C optimizes economy and convenience

The affordable 8752C network analyzer provides outstanding performance and numerous productivity features to simplify and speed your component measurements in the 300 kHz to 6 GHz frequency range.

The 8752C vector network analyzer measures the transmission and reflection characteristics of devices and networks by applying a known swept signal from a synthesized source. The test signal is

separated from incident signals by a fully integrated test set. The response is displayed in a variety of useful formats. The 8752C easily and quickly measures a device's reflection coefficient, return loss, phase, gain, isolation, group delay, and deviation from linear phase in transmission.

The 8752C not only provides magnitude and phase information, but also offers up to 110 dB dynamic range, makes group-delay and time-domain measurements, and uses vector accuracy enhancement to minimize measurement uncertainty.



Agilent Technologies

Innovating the HP Way

A complete solution

With an integrated transmission/reflection test set, the 8752C is a complete 50 or 75 ohm measurement system that is only 18 cm (7 in) high—ideal for small spaces or crowded benchtops. Installation and operation are fast and easy; just connect the power cord, turn on the instrument, connect your device, and start the measurement. The CPU clock rate is 67% faster than the 8752A or 8752B for faster error correction, time-domain calculations, and data transfers.

Key features add performance and value

Frequency

Coverage is 300 kHz to 1.3 GHz with optional frequency extensions to 3 or 6 GHz.

Test set

Built-in test set for transmission and reflection measurements.

Two independent channels

Two independent display channels allow simultaneous display of transmission and reflection measurements, magnitude and phase, or time-domain and swept-frequency measurements.

Simple operation

Hardkey interface helps you quickly and easily access all primary instrument functions.

Large color display

A large 19 cm (7.5 in) full-color display makes measurement data, annotations, and softkey selections easy to read. Use the default colors, or customize the colors according to your needs.

Easy access to additional instrument functions

Just press the hardkeys to display softkeys menus that clearly guide you through instrument functions.

Built-in synthesized source

An integrated synthesized source with 1 Hz resolution speeds up instrument performance for swept measurements. Choose a frequency range to meet your particular application. Optional step attenuator extends source output power range.

Test sequencing

Use test sequencing, an easy, powerful form of keystroke recording, to internally configure and

automate measurements. New test sequencing capabilities include the use of subroutines.

Save/recall

Save and recall test sequences, measured data, calibration data and instrument states to the internal memory or use an optional external disk drive. Nonvolatile memory allows internal storage of up to 31 instrument states.

Copy

Make direct black and white or color hardcopies to a plotter or printer over the GPIB.

Powerful options

Extended frequency coverage

Characterize your components beyond the standard frequency range of the 8752C. Option 003 allows operation to 3 GHz and Option 006 to 6 GHz.

Time-domain analysis

Locate and resolve discontinuities in devices by displaying impedance versus distance. Gain additional insight into a device's behavior by displaying the step response or by using gating to remove unwanted responses such as connector mismatch.

Improved output power range (Option 004)

Add a built-in step attenuator for output power range from -85 to +10 dBm.

Productivity features to speed and simplify your measurements

Pass/fail testing

Reduce test times by letting the network analyzer determine if measurement results are within user-defined limits. You can easily choose any combination of single-point, horizontal or sloping line limits from the front panel. Pass or fail is indicated visually from the display, audibly with a beep, over GPIB, or from a BNC rear-panel TTL output.

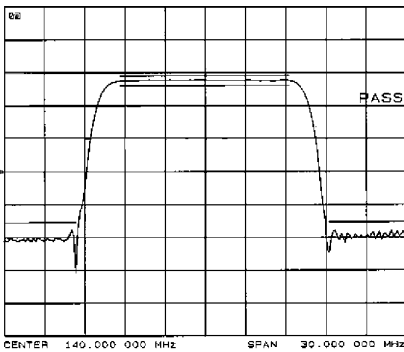

Easily discern whether a device passes or fails

Change frequencies and remain calibrated

Save time and avoid recalibration when changing frequencies by using the interpolative error-correction mode. Perform a broadband calibration with up to 1,601 points and then reduce your frequency span or number of measurement points for the particular device under test. The Agilent 8752C automatically recalculates the error terms based on the new values of either parameter. This gives you the flexibility of investigating your device's performance over any portion of the calibrated frequency range while maintaining full display resolution.

Automate repetitive tasks, without a computer

In test-sequencing mode, make a measurement once and the network analyzer "learns" the keystrokes. You can store complex measurements in a sequence and later recall them rapidly with the touch of a button. You create a sequence with the same front panel keystrokes used during manual operation, so no programming expertise is required. Display operator prompts for tuning and manual adjustments, or make pass/fail decisions during sequence execution. You can even control other GPIB instruments, or use the parallel port to control part handlers.

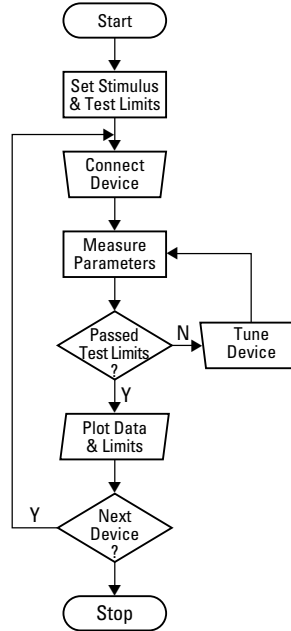

Test sequence flowchart

User-defined frequency testing

Speed up your testing by measuring your device at only selected frequencies. You can specify up to 30 arbitrary CW frequencies or frequency sweep segments at which to test your device. By measuring at only the needed frequencies, you reduce test time and increase measurement throughput.

	STIMULUS	CH1 S11	CH1 S11
	MHz		
1	000.000 000	6.4336 n	-54.621 n
1	080.000 000	5.6387 n	-39.094 n
1	160.000 000	5.7207 n	-27.716 n
1	240.000 000	4.3707 n	-17.897 n
1	320.000 000	4.0137 n	-9.2217 n
1	400.000 000	3.6646 n	-938.84 mΩ
1	480.000 000	3.46 n	7.7507 n
1	560.000 000	3.2031 n	16.772 n
1	640.000 000	3.2041 n	26.993 n
1	720.000 000	3.5059 n	40.039 n
1	800.000 000	4.6074 n	57.623 n
1	880.000 000	7.8984 n	84.496 n
1	960.000 000	19.813 n	136.48 n
2	040.000 000	93.852 n	253.37 n
2	120.000 000	614.97 n	34.906 n
2	200.000 000	109.79 n	-238.26 n
2	280.000 000	29.398 n	-130.01 n
2	360.000 000	12.313 n	-81.332 n
2	440.000 000	4.3984 n	-53.271 n
2	520.000 000	2.4375 n	-33.035 n
2	600.000 000	1.7969 n	-18.356 n
2	680.000 000	1.6273 n	-3.7665 n
2	760.000 000	3.8452 n	13.731 n
2	840.000 000	12.646 n	35.244 n
2	920.000 000	61.047 n	53.156 n
3	000.000 000	57.904 n	1.9297 n

Example of "list frequency" output

Transfer data to your CAE program

Use an external disk drive to store ASCII disk files in conformance to the CITIFILE standard with the 8752C. Measured data can then be read by CAE applications, including EEs of design software, and used for circuit simulation. These programs can also access data directly via GPIB.

The Agilent 8700 vector network analyzers

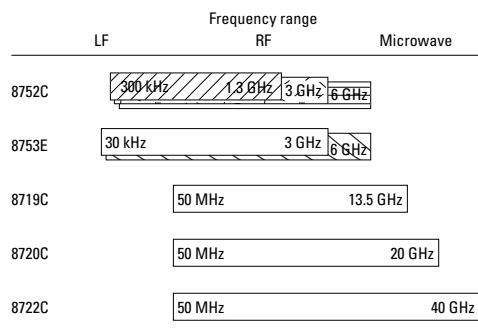

The 8700 series of vector network analyzers provides exceptional value in terms of price and performance

Summary of 8752C and 8753E key features and differences

Feature	8752C	8753E
Frequency range (standard)	300 kHz to 1.3 GHz	30 kHz to 3 GHz
Extended frequency range options	300 kHz to 3 GHz 300 kHz to 6 GHz	30 kHz to 6 GHz
Test set	Transmission/Reflection	S-parameter External test sets with Option 011
Test port power range	-20 to +5 dBm (standard) -85 to +10 dBm (Option 004)	-85 to +10 dBm (standard)
Dynamic range	300 kHz to 3 GHz: 110 dB ² 3 GHz to 6 GHz: 105 dB	30 kHz to 50 kHz: 90 dB ¹ 50 kHz to 300 kHz: 100 dB ¹ 300 kHz to 3 GHz: 110 dB ² 3 GHz to 6 GHz: 105 dB
Internal disk drive	No	Yes (LIF/DOS)
Accuracy enhancement		
Response	Yes	Yes
One-port	Yes	Yes
Full two-port	No	Yes
TRL*/LRM*	No	Yes
Test sequencing	Yes	Yes
Limit lines	Yes	Yes
GPIB plotter/printer port interface	Yes	Yes
Serial/parallel plotter/printer port interface	No	Yes
Time domain option	Yes	Yes
Power meter calibration	No	Yes
Mixer measurement capability	No	Yes
Absolute power measurements	No	Yes
Harmonic measurement option	No	Yes
High-stability frequency reference	No	Yes
DC bias to device under test	No	Yes

1. Typical

2. 100 dB from 300 kHz to 16 MHz due to fixed spurs

Agilent 8752C (50-ohm systems) Type-N test ports

The following specifications describe the system performance of the 8752C 50-ohm network analyzer. System hardware includes the following (a transmission/reflection test set is built into the analyzer, and the cable is shipped with the 8752C).

Network analyzer	8752C Option 006
Calibration kit	85032B
Test port cable	part number 8120-4781

Dynamic range

These specifications apply to transmission measurements in the 300 kHz to 6 GHz frequency range at 10 Hz IF BW with response and isolation correction. Dynamic range is limited by maximum receiver input level and the receiver's noise floor.

System dynamic range:

300 kHz to 1.3 GHz	110 dB ¹
1.3 GHz to 3 GHz	110 dB
3 GHz to 6 GHz	105 dB

Typical measurement uncertainty²

The following graphs show the typical measurement uncertainty for the 8752C over the full frequency range with error correction. Total uncertainties can be improved using one-port error correction for reflection measurements, and response and isolation error correction for transmission measurements.

Transmission measurements³

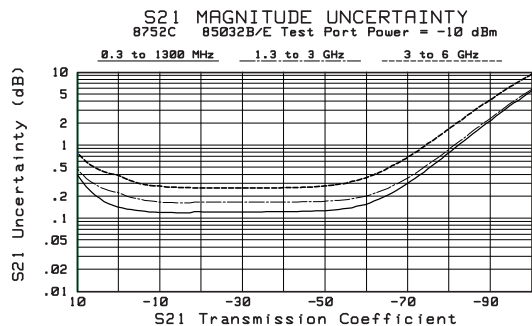

Magnitude

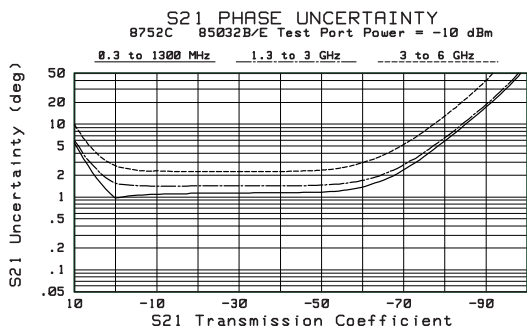

Phase

Measurement port characteristics

The following specifications show the residual 8752C system uncertainties with and without error correction. These characteristics apply for an environmental temperature of 25 ±5 °C, with less than 1 °C deviation from the calibration temperature. Option 004 may degrade transmission source match as much as 2 dB, resulting in up to 0.05 dB additional uncertainty in transmission tracking.

	Frequency Range		
Corrected	300 kHz- 1.3 GHz	1.3 GHz- 3 GHz	3 GHz- 6 GHz
Directivity	50 dB	47 dB	40 dB
Source match (reflection)	42 dB	36 dB	31 dB
Reflection tracking	±0.009 dB	±0.019 dB	±0.070 dB
Source match (transmission)	23 dB	20 dB	20 dB
Load match	23 dB*	20 dB	20 dB
Transmission tracking	±0.043 dB*	±0.086 dB	±0.137 dB
Uncorrected			
Directivity	40 dB**	35 dB	30 dB
Source match (reflection)	30 dB	25 dB	20 dB
Reflection tracking	±0.2 dB	±0.3 dB	±0.4 dB
Source match (transmission)	23 dB	20 dB	16 dB
Load match	23 dB*	20 dB	20 dB
Transmission tracking	±0.2 dB	±0.3 dB	±0.4 dB
Crosstalk	100 dB	100 dB	90 dB

* Load match is 14 dB from 300 kHz to 10 MHz for Option 006, resulting in transmission tracking of ±0.13 dB.

** 30 dB, 300 kHz to 10 MHz

Reflection measurements⁴

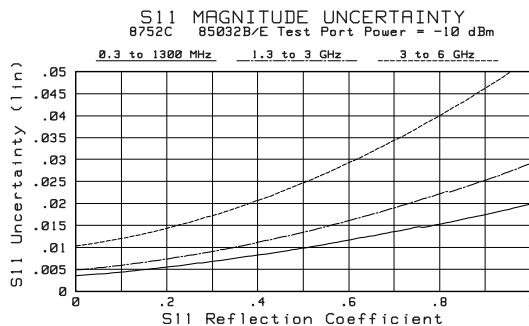

Magnitude

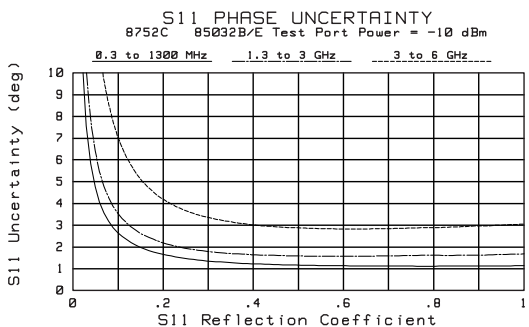

Phase

- 100 dB, 300 kHz to 16 MHz due to fixed spurs
- These measurement uncertainty curves utilize an RSS model for the contribution of random errors such as noise, typical connector repeatabilities, and test set switches with a worst-case model for the contributions of dynamic accuracy and residual systematic errors.

Agilent 8752C (75-ohm systems) Type-N test ports

The following specifications describe the system performance of the 8752C 75-ohm network analyzer. System hardware includes the following (a transmission/reflection test set is built into the analyzer, and the cable is shipped with the 8752C):

Network analyzer	8752C Option 075
Calibration kit	85036A
Test port cable	part number 8120-2408

Dynamic range

These specifications apply to transmission measurements in the 300 kHz to 3 GHz frequency range at 10 Hz IF BW with response and isolation correction. Dynamic range is limited by maximum receiver input level and the receiver's noise floor.

System dynamic range:

300 kHz to 1.3 GHz	105 dB ¹
1.3 GHz to 3 GHz	105 dB

Typical measurement uncertainty²

The following graphs show the typical measurement uncertainty for the 8752C over the full frequency range with error correction. Total uncertainties can be improved using one-port error correction for reflection measurements, and response and isolation error correction for transmission measurements.

Transmission measurements³

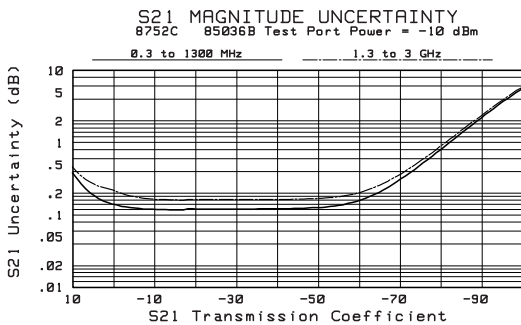

Magnitude

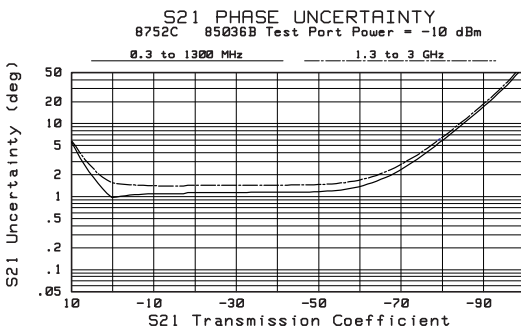

Phase

Measurement port characteristics

The following specifications show the residual 8752C system uncertainties with and without error correction. These characteristics apply for an environmental temperature of 25 ±5 °C, with less than 1 °C deviation from the calibration temperature. Option 004 may degrade transmission source match as much as 2 dB, resulting in up to 0.05 dB additional uncertainty in transmission tracking.

	Frequency Range	
	300 kHz to 1.3 GHz	1.3 GHz to 3 GHz
Corrected		
Directivity	48 dB	43 dB
Source match (reflection)	41 dB	35 dB
Reflection tracking	±0.010 dB	±0.019 dB
Source match (transmission)	23 dB	20 dB
Load match	23 dB	20 dB
Transmission tracking	±0.044 dB	±0.087 dB
Uncorrected⁵		
Directivity	40 dB*	35 dB
Source match (reflection)	30 dB	25 dB
Reflection tracking	±0.2 dB	±0.3 dB
Source match (transmission)	23 dB	20 dB
Load match	23 dB	20 dB
Transmission tracking	±0.2 dB	±0.3 dB
Crosstalk	100 dB	97 dB

* 30 dB from 300 kHz to 10 MHz

Reflection measurements⁴

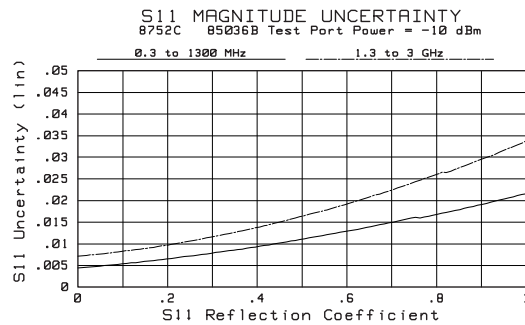

Magnitude

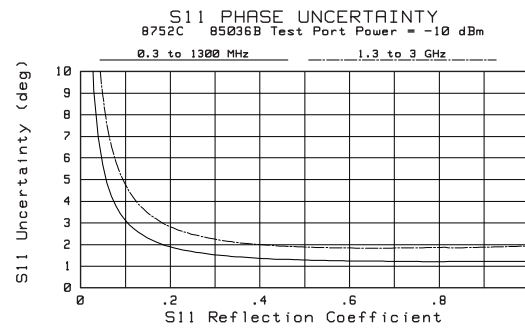

Phase

3. The graphs shown for transmission measurements assume a well-matched device ($S_{11} = S_{22} = 0$).

4. The graphs shown for reflection measurements apply to either a one-port device or a two-port device with more than 6 dB of insertion loss.

5. Typical

Test port output characteristics

Frequency characteristics

Range	300 kHz to 1.3 GHz
Option 003	300 kHz to 3 GHz
Option 006	300 kHz to 6 GHz
Resolution	1 Hz
Stability	±7.5 ppm 0 °C to 55 °C
Accuracy	±10 ppm at 25 °C ±5 °C

Output characteristics

Test port power range	-20 to +5 dBm (standard) -85 to +10 dBm (Option 004) -85 to +8 dBm (Options 004 and 075)
Resolution	0.05 dB
Level accuracy^{1,2}	±1 dB
Level linearity^{1,2}	(-20 to -15 dBm) ±0.5 dB (-15 to 0 dBm) ±0.2 dB (0 to +5 dBm) ±0.5 dB
Option 004	(-15 to +5 dBm) ±0.2 dB (+5 to +10 dBm) ³ ±0.5 dB
Impedance	50 Ω nominal 75 Ω nominal (Option 075)

Test port input characteristics

Frequency range:	300 kHz to 1.3 GHz
Option 003	300 kHz to 3 GHz
Option 006	300 kHz to 6 GHz
Noise level	
3 kHz BW	Reflection -75 dBm (typical)
10 Hz BW	Reflection -85 dBm (typical)
3 kHz BW	Transmission -90 dBm
10 Hz BW	Transmission -110 dBm
Option 006, from 3 GHz to 6 GHz	
3 kHz BW	Transmission -85 dBm
10 Hz BW	Transmission -105 dBm
Max. input level	0 dBm at transmission port 10 dBm at reflection port
Damage level	
Standard, Opt. 003, or Option 075	20 dBm or 25 VDC at both test ports
Option 006	20 dBm or 25 VDC at reflection ports 20 dBm or 10 VDC at transmission port
Crosstalk	
(Reflection port to transmission port)	300 kHz to 1.3 GHz 100 dB 1.3 GHz to 3 GHz 100 dB 3 GHz to 6 GHz 90 dB
Option 075	300 kHz to 1.3 GHz 100 dB 1.3 GHz to 3 GHz 97 dB

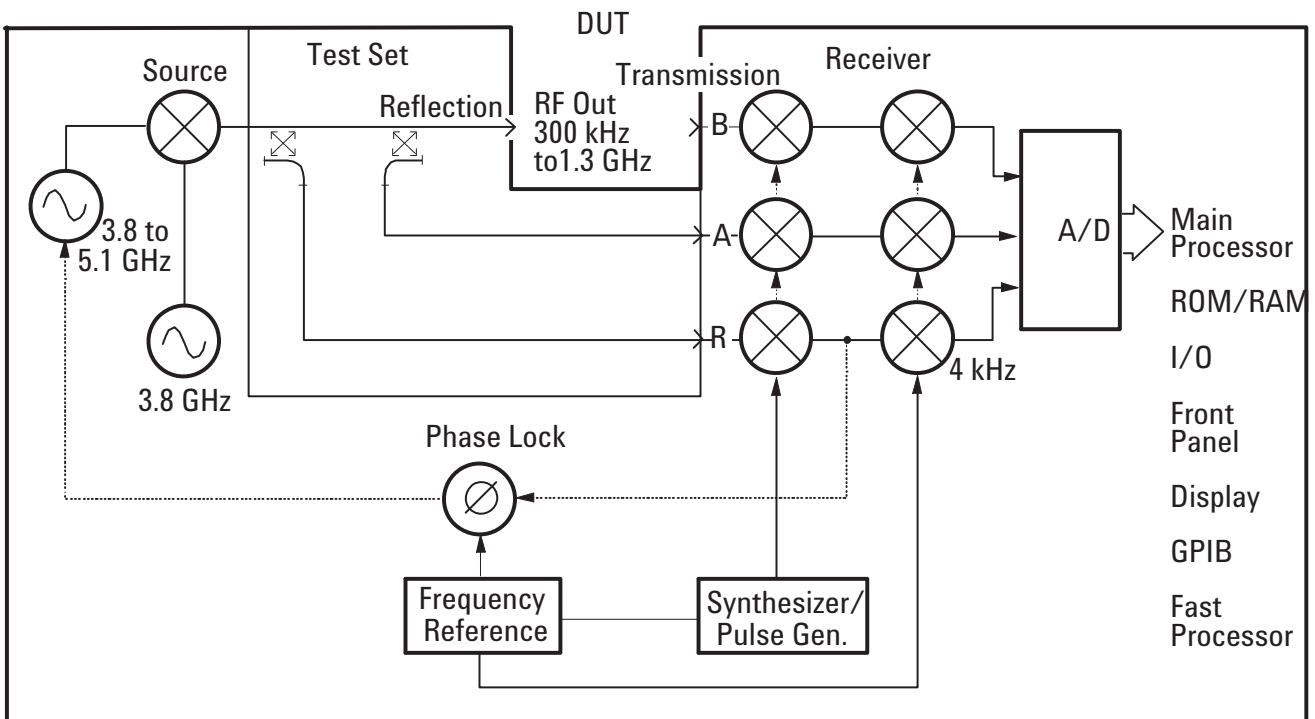

Agilent 8752C Block Diagram

1. At 25 °C ±5 °C, relative to -5 dBm output power for the 8752C
 2. Typical from 2 to 3 GHz for instruments with Option 075
 3. +5 to +8 dBm for Option 075

Ordering information

Agilent 8752C network analyzer (300 kHz to 1.3 GHz, 3 GHz, or 6 GHz systems)

□ 8752C network analyzer

Integrated network analyzer with built-in color display, transmission/reflection test set, and synthesized 300 kHz to 1.3 GHz source.

Includes one Type-N male to Type-N male test port cable, where errors have been removed by the built-in factory calibration. An operating and programming manual set is included with each instrument.

- **Option 003** 3-GHz frequency extension
Provides source and receiver operation to 3 GHz. Do not order both Option 003 and Option 006.
- **Option 004** Step attenuator
Provides source output power range from -85 to +10 dBm (except with Option 075 where max. power is +8 dBm).
- **Option 006** 6-GHz frequency extension
Provides source and receiver operation to 6 GHz. Do not order Option 006 with Option 003 or Option 075.
- **Option 010** Time-domain capability
For viewing reflection and transmission responses in time or distance domain.
- **Option 075** 75-ohm impedance
Test ports are 75-ohm Type-N connectors. Do not order Option 075 with Option 006.
- **Option 802** Adds dual disk drive and GPIB cable
- **Option AFN** Adds 50-ohm test-port cable (part number 08752-60027). Provides a second Type-N male to Type-N male test port cable, part number 8120-5639, and a Type-N female to Type-N female adapter, part number 1250-1472. Instructions are provided for storing a new internal calibration to account for the effect of this cable.

- **Option AFP** Adds 75-ohm test-port cable (part number 08752-60028). Provides a 75-ohm Type-N male to Type-N female cable, part number 8120-2409. Instructions are provided for storing a new internal calibration to account for the effect of this cable.
- **Option 0B0** Deletes operating manual set
- **Option 0B1** Adds extra operating manual set (part number 08752-90134), includes:
 - 8752C User's Guide (part number 08752-90135)
 - 8752C Programmer's Guide (part number 08752-90137)
 - 8752C Installation & Quick Start Guide (part number 08752-90139)
 - 8752C Verification & Test Guide (part number 08752-90157)
- **Option 1CM** Rack mount kit (without handles) (part number 5062-3978)
- **Option 1CP** Rack mount kit with handles (part number 5062-4072)
- **Option 1BN** MIL-STD 45662A calibration certification
- **Option 1BP** MIL-STD 45662A calibration with test data
- **Option UK6** Commercial calibration certificate with test data
- **Option W08** Convert the one-year on-site warranty to three-year return-to-Agilent warranty.
- **Option W31** Two additional years of on-site service (where available)

The following localization options provide manuals that are partially or completely translated into the specified languages, depending on the region.

Option AB0	Taiwan–Chinese localization (part number 08752-90146)
Option AB2	China–Chinese localization (part number 08752-90147)
Option ABD	Germany–German localization (part number 08752-90148)
Option ABE	Spain–Spanish localization (part number 08752-90149)
Option ABF	France–French localization (part number 08752-90150)
Option ABJ	Japan–Japanese localization (part number 08752-90151)
Option ABZ	Italy–Italian localization (part number 08752-90152)

Measurement accessories

Accessories are available in these connector types: 50-ohm Type-N, 75-ohm Type-N, 3.5-mm, BNC, and Type-F. The Agilent 8752C's internal error correction compensates for loss and mismatch errors up to its Type-N test ports. For most applications, no additional calibration is required. External user calibration is recommended to remove the effects of cables and adapters that are not part of the system, or when the highest accuracy is desired.

Calibration kits include standards that are required for vector accuracy enhancement. Unlike the 8753D system, the 8752C does not offer a verification kit. Instead, the 85032B 50-ohm and 85036B 75-ohm Type-N calibration kits can be used to verify the performance of these systems.

Calibration kits

Choose a kit for each connector type to be used.

- 85032B** 50-ohm Type-N calibration kit
Contains fixed loads, opens and short circuits, and 7-mm to Type-N adapters for both connector sexes. This kit is also used to verify the 8752C system performance.
 - Option 001** Deletes 7-mm to Type-N adapters. These adapters are not needed when this kit is used exclusively with an 8752C system.
- 85033D** 3.5-mm calibration kit. Contains fixed loads, opens and short circuits, and 7-mm to 3.5-mm adapters for both connector sexes.
 - Option 001** Deletes 7-mm to 3.5-mm adapters. These adapters are not needed when this kit is used exclusively with an 8752C system.
- 85036B** 75-ohm Type-N calibration kit.
Contains 75-ohm fixed loads, opens and short circuits, and 75-ohm Type-N adapters of both connector sexes. This kit is also used to verify the 8752C Option 075 system performance.
- 85039B** Type-F calibration kit. Contains fixed load, opens and short circuits for both connector sexes, precision adapters F(f) to N(m), F(m) to N(f), F(m) to F(m), F(f) to F(f).
 - Option 00M** Male standards kit. Includes male open, short and load standards and precision F(m) to F(m) adapter
 - Option 00F** Female standards kit. Includes female open, short and load standards and precision F(f) to F(f) adapter

Ordering information, continued

Adapters

- 11852B** 50 to 75-ohm minimum loss pad (300 kHz to 3 GHz). Adapts from 50-ohm Type-N female to 75-ohm Type-N male. Nominal insertion loss is 5.7 dB.
- Option 004** Provides 50-ohm Type-N male and 75-ohm Type-N female connectors
- 11853A** 50-ohm Type-N accessory kit. Contains Type-N male to Type-N female adapters, Type-N female to Type-N female adapters, and Type-N male and female shorts.
- 11854A** 50-ohm BNC accessory kit. Contains Type-N to BNC adapters and a BNC male short.
- 11855A** 75-ohm Type-N accessory kit. Contains 75-ohm Type-N male to Type-N male adapters, Type-N female to Type-N female adapters, Type-N male and female shorts, and Type-N male termination.
- 11856A** 75-ohm BNC accessory kit. Contains 75-ohm Type-N to 75-ohm BNC adapters for both connector sexes, a BNC male short, and BNC male termination.
- 11878A** 3.5-mm adapter kit. Contains 50-ohm Type-N to 3.5-mm adapters.
- Part number 08752-60020** Input/output control adapter. Attaches to the “test set interconnect” on the rear panel of the 8752C to allow access to general purpose input/output signal lines. Female SMB connectors are provided for four TTL outputs, one TTL input, an end-of-sweep output, and a limit-test output.

Test-port cables

- Part number 8120-5639** 50-ohm Type-N test-port cable (both connectors are Type-N male)
- Part number 8120-2408** 75-ohm Type-N test-port cable (both connectors are Type-N male)
- Part number 8120-2409** 75-ohm Type-N test-port cable (one male, one female connector)

Other accessories

Retrofit kits

These kits are used to add additional capability to the Agilent 8752C.

- 11885A** 3-GHz frequency extension upgrade kit. Includes installation at a local Agilent service center. The serial number of the 8752C to be retrofitted must be specified when ordering this kit.
- 11884D** 6-GHz upgrade kit for the 8752C. Includes installation at a local Agilent service center. The serial number of the 8752C to be retrofitted must be specified when ordering this kit. Do not use with an 8752C that has Option 075.
- 85019C** Time-domain retrofit kit. The serial number of the 8752C to be retrofitted must be specified when ordering this kit. Installation not included.
- Part number 08752-60019** Step attenuator retrofit kit Installation is not included.

Transit case

- Part number 9211-2656 valise transit case. Protects the analyzer from shock, vibration, moisture, impact, and contamination to provide a secure enclosure for shipping.

RF limiter

- 11930B Type-N RF limiter. Externally attaches to one or both parts of the analyzer. Provides protection against potential high-power transients from external devices.

Probe

- 85024A high-frequency probe. Provides high-impedance in-circuit test capability, from 300 kHz to 3 GHz.

Printers

For a list of compatible printers, consult our printer-compatibility guide web page: www.agilent.com/find/pcg

Service and support products

The Agilent 8752C includes a one-year on-site service warranty at no extra charge. On-site service may not be available in all areas. Return-to-Agilent service is provided where on-site service is unavailable. Customers may convert the standard one-year on-site warranty to a three-year return-to-Agilent warranty by ordering Option W08. Option W08 must be specified at the time of the analyzer's purchase.

Selected service and support products are listed below. For more information on training, service, and support products for these analyzers, consult your local Agilent sales and service office.

Follow-on on-site service

- 8752C
 - Option W31** adds two additional years of on-site service.

Calibration agreements

- 8752C
 - Option W32** adds a three-year customer-return calibration agreement.
 - Option W34** adds a three-year customer-return standards-compliant calibration agreement.
 - Option W54** adds a five-year customer-return standards-compliant calibration agreement.
 - Option W52** adds a five-year customer-return calibration agreement.

Agilent Technologies' Test and Measurement Support, Services, and Assistance

Agilent Technologies aims to maximize the value you receive, while minimizing your risk and problems. We strive to ensure that you get the test and measurement capabilities you paid for and obtain the support you need. Our extensive support resources and services can help you choose the right Agilent products for your applications and apply them successfully. Every instrument and system we sell has a global warranty. Support is available for at least five years beyond the production life of the product. Two concepts underlie Agilent's overall support policy: "Our Promise" and "Your Advantage."

Our Promise

"Our Promise" means your Agilent test and measurement equipment will meet its advertised performance and functionality. When you are choosing new equipment, we will help you with product information, including realistic performance specifications and practical recommendations from experienced test engineers. When you use Agilent equipment, we can verify that it works properly, help with product operation, and provide basic measurement assistance for the use of specified capabilities, at no extra cost upon request. Many self-help tools are available.

Your Advantage

"Your Advantage" means that Agilent offers a wide range of additional expert test and measurement services, which you can purchase according to your unique technical and business needs. Solve problems efficiently and gain a competitive edge by contracting with us for calibration, extra-cost upgrades, out-of-warranty repairs, and on-site education and training, as well as design, system integration, project management, and other professional services. Experienced Agilent engineers and technicians worldwide can help you maximize your productivity, optimize the return on investment of your Agilent instruments and systems, and obtain dependable measurement accuracy for the life of those products.

By internet, phone, or fax, get assistance with all your test and measurement needs.

Online Assistance

www.agilent.com/find/assist

Phone or Fax

United States:

(tel) 1 800 452 4844

Canada:

(tel) 1 877 894 4414

(fax) (905) 206 4120

Europe:

(tel) (31 20) 547 2323

(fax) (31 20) 547 2390

Japan:

(tel) (81) 426 56 7832

(fax) (81) 426 56 7840

Latin America:

(tel) (305) 269 7500

(fax) (305) 269 7599

Australia:

(tel) 1 800 629 485

(fax) (61 3) 9272 0749

New Zealand:

(tel) 0 800 738 378

(fax) (64 4) 495 8950

Asia Pacific:

(tel) (852) 3197 7777

(fax) (852) 2506 9284

Product specifications and descriptions in this document subject to change without notice.

Copyright © 1998, 2000 Agilent Technologies
Printed in U.S.A. 7/00
5966-0056E



Agilent Technologies

Innovating the HP Way